

STAGE SIZE - 15'w x 10'h x 10'd

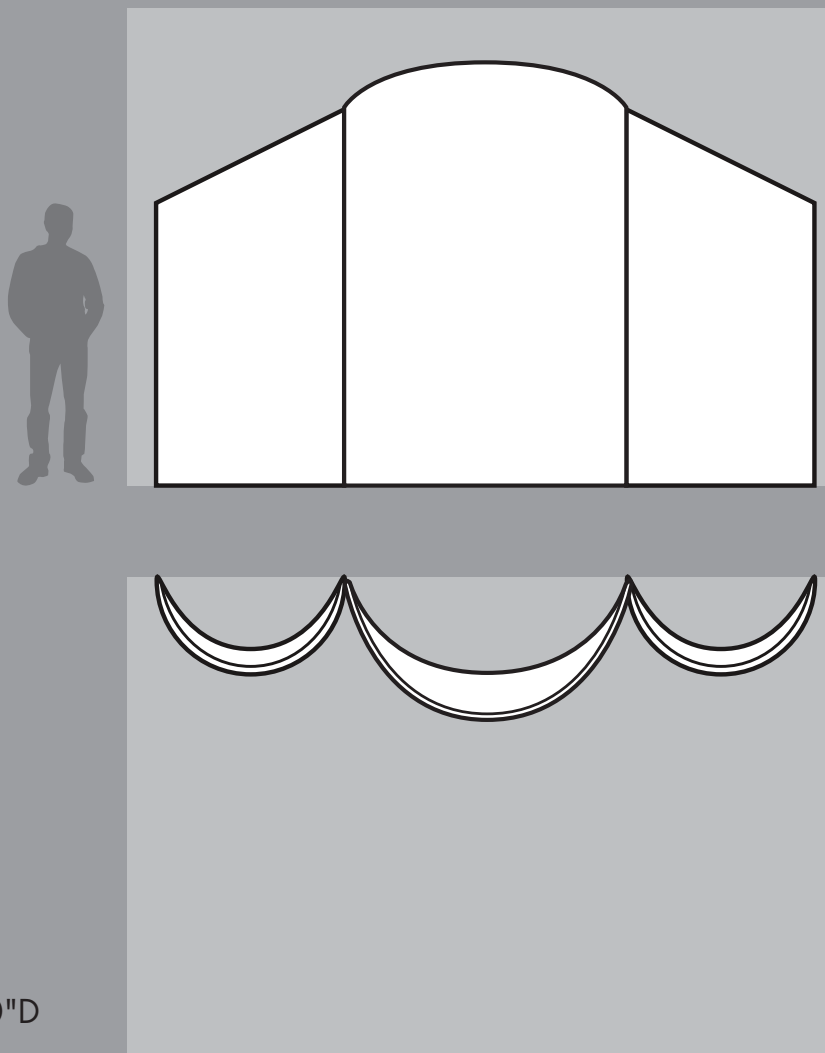

- (2) SLENDER SLOPE - 4'W X 8'H X 24"D
- (1) WAVE WALL SMALL - 6'W X 9'H X 30"D

Any and all rights (including, without limitation, copyright, design patent, use patent and trademark) in and to all designs, concepts, renderings, or graphics (collectively, "Design") represented in this document were created by Pink Inc. and remain the sole and exclusive property of Pink Inc. Use of any such Design by the recipient without required purchase is strictly prohibited.

©2010

STAGE SIZE - 15'w x 10'h x 10'd

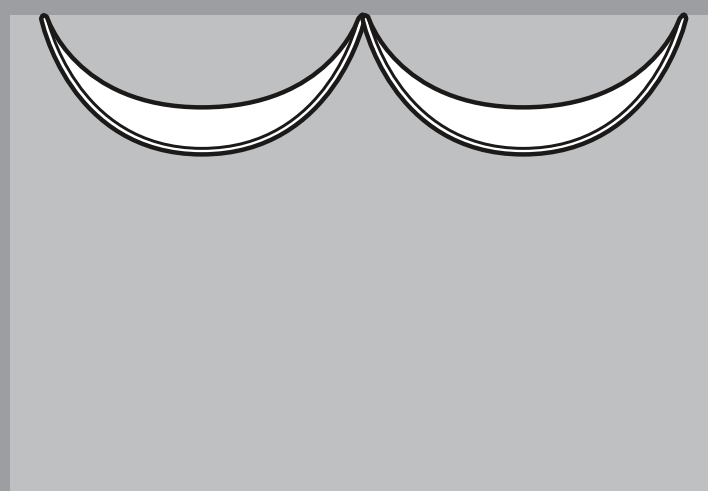
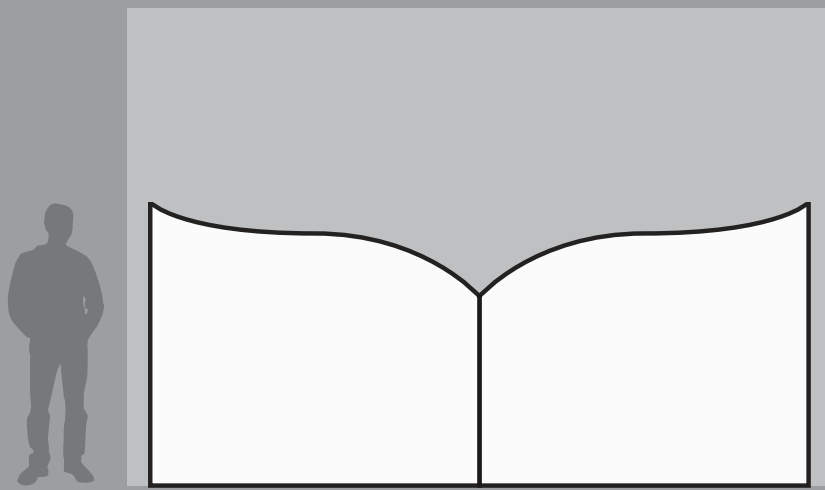

(2) SMALL SLOPE - 7'W X 6'H X 30"D

Any and all rights (including, without limitation, copyright, design patent, use patent and trademark) in and to all designs, concepts, renderings, or graphics (collectively, "Design") represented in this document were created by Pink Inc. and remain the sole and exclusive property of Pink Inc. Use of any such Design by the recipient without required purchase is strictly prohibited.

©2010

STAGE SIZE - 15'w x 10'h x 10'd

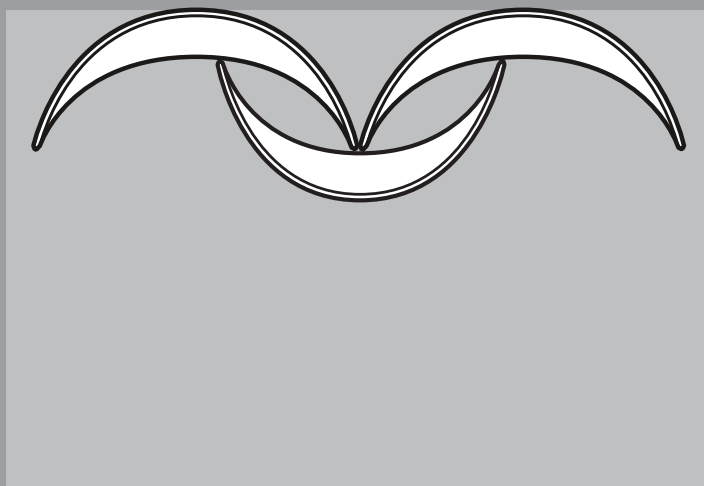
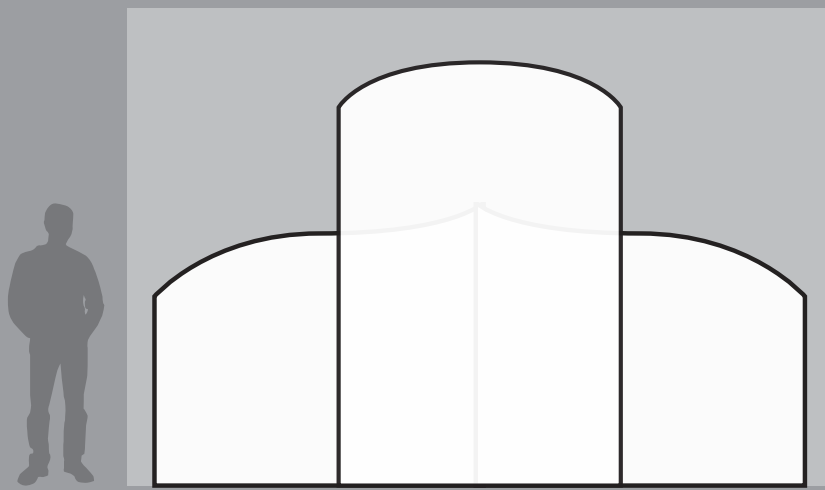

(2) SMALL SLOPE - 7'W X 6'H X 30"D

(1) WAVE WALL SMALL - 6'W X 9'H X 30"D

Any and all rights (including, without limitation, copyright, design patent, use patent and trademark) in and to all designs, concepts, renderings, or graphics (collectively, "Design") represented in this document were created by Pink Inc. and remain the sole and exclusive property of Pink Inc. Use of any such Design by the recipient without required purchase is strictly prohibited.

©2010

STAGE SIZE - 15'w x 10'h x 10'd

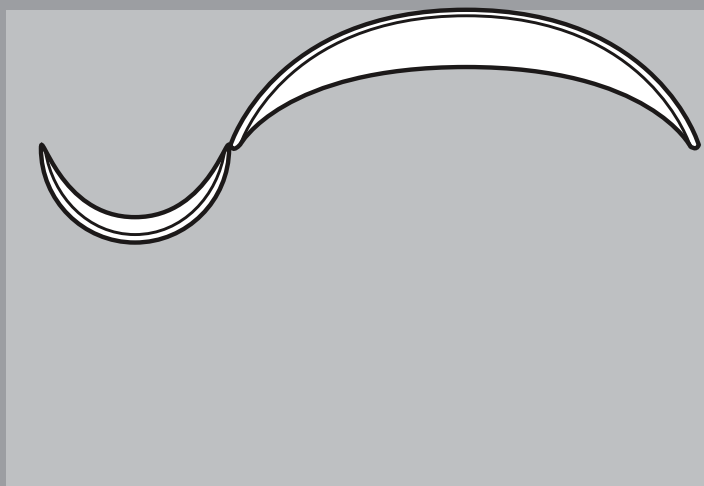
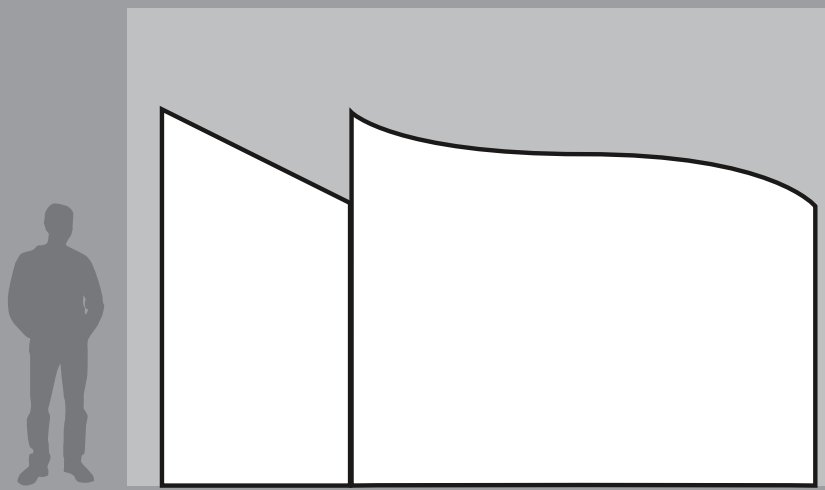

- (1) SLENDER SLOPE - 4'W X 8'H X 24"D
- (1) LARGE SLOPE - 10'W X 8'H X 36"D

Any and all rights (including, without limitation, copyright, design patent, use patent and trademark) in and to all designs, concepts, renderings, or graphics (collectively, "Design") represented in this document were created by Pink Inc. and remain the sole and exclusive property of Pink Inc. Use of any such Design by the recipient without required purchase is strictly prohibited.

©2010

STAGE SIZE - 20'w x 10'h x 10'd

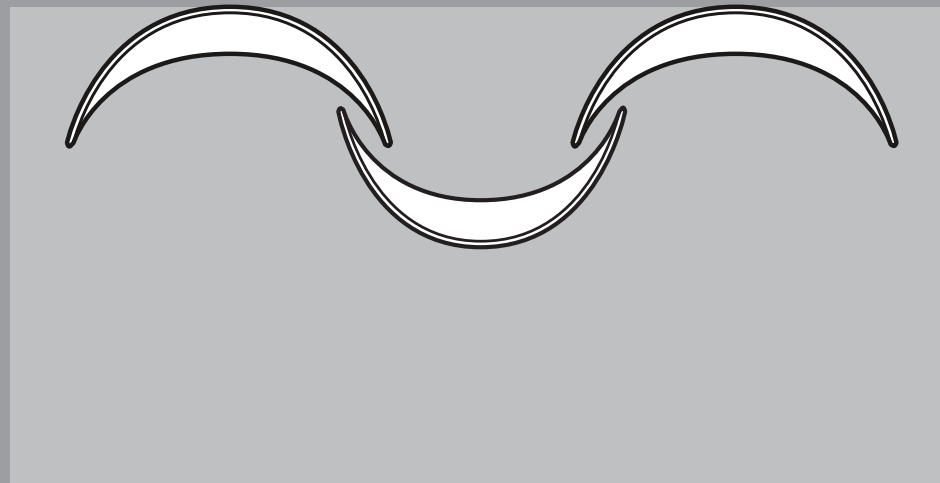
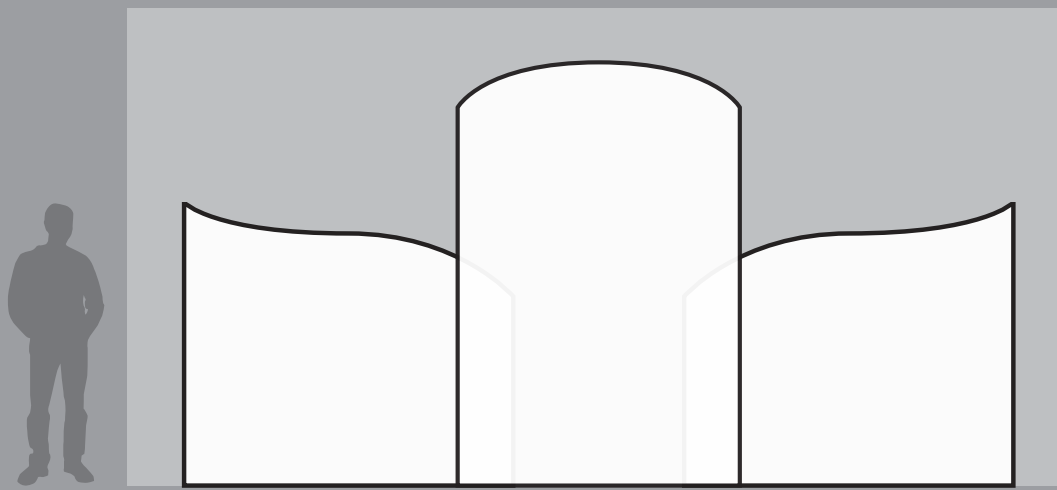

(2) SMALL SLOPE - 7'W X 6'H X 30"D
 (1) WAVE WALL SMALL - 6'W X 9'H X 30"D

Any and all rights (including, without limitation, copyright, design patent, use patent and trademark) in and to all designs, concepts, renderings, or graphics (collectively, "Design") represented in this document were created by Pink Inc. and remain the sole and exclusive property of Pink Inc. Use of any such Design by the recipient without required purchase is strictly prohibited.

©2010

STAGE SIZE - 20'w x 10'h x 12'd

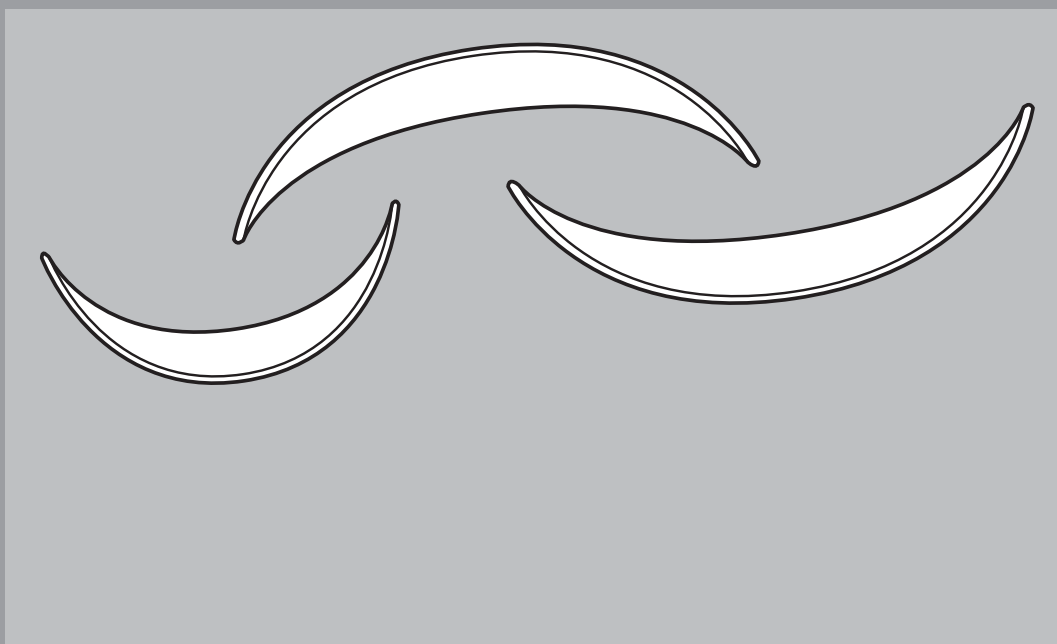
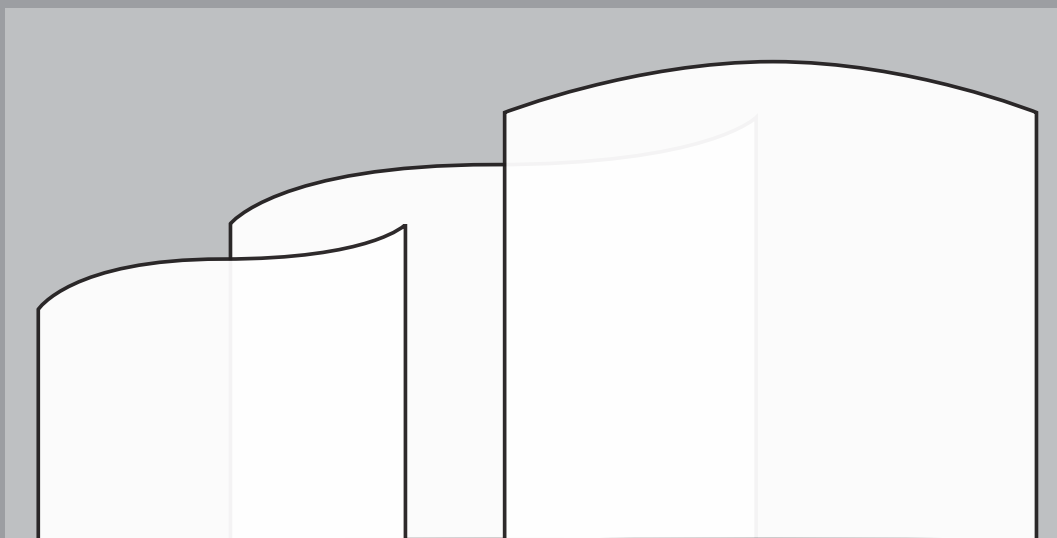

- (1) SMALL SLOPE - 7'W X 6'H X 30"D
- (1) LARGE SLOPE - 10'W X 8'H X 36"D
- (1) WAVE WALL LARGE 10'W X 9'H X 3'D

Any and all rights (including, without limitation, copyright, design patent, use patent and trademark) in and to all designs, concepts, renderings, or graphics (collectively, "Design") represented in this document were created by Pink Inc. and remain the sole and exclusive property of Pink Inc. Use of any such Design by the recipient without required purchase is strictly prohibited.

©2010

STAGE SIZE - 30'w x 12'h x 12'd

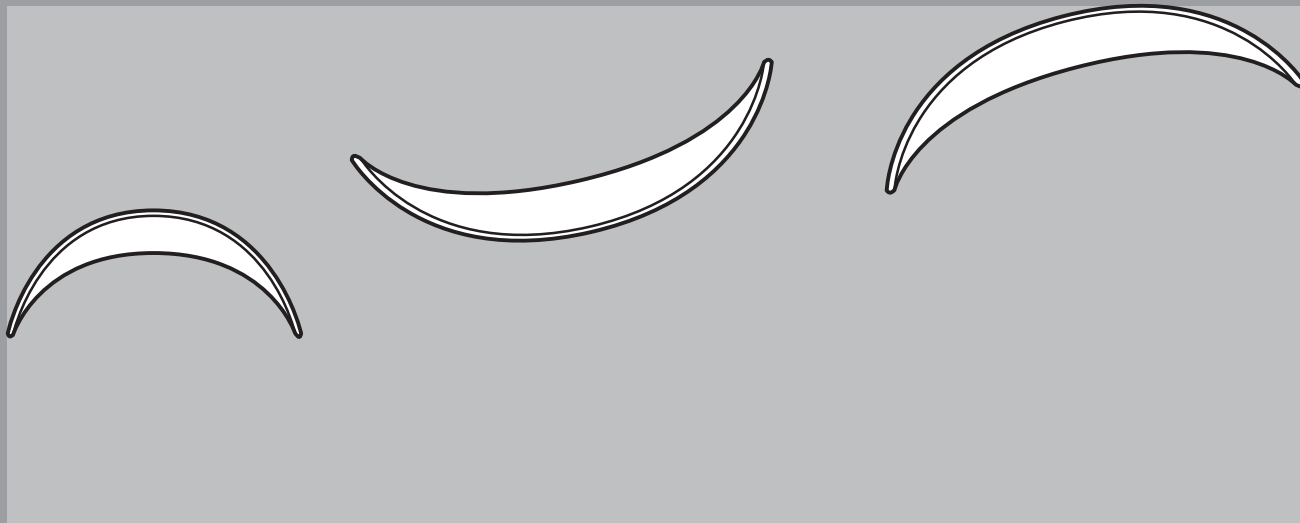
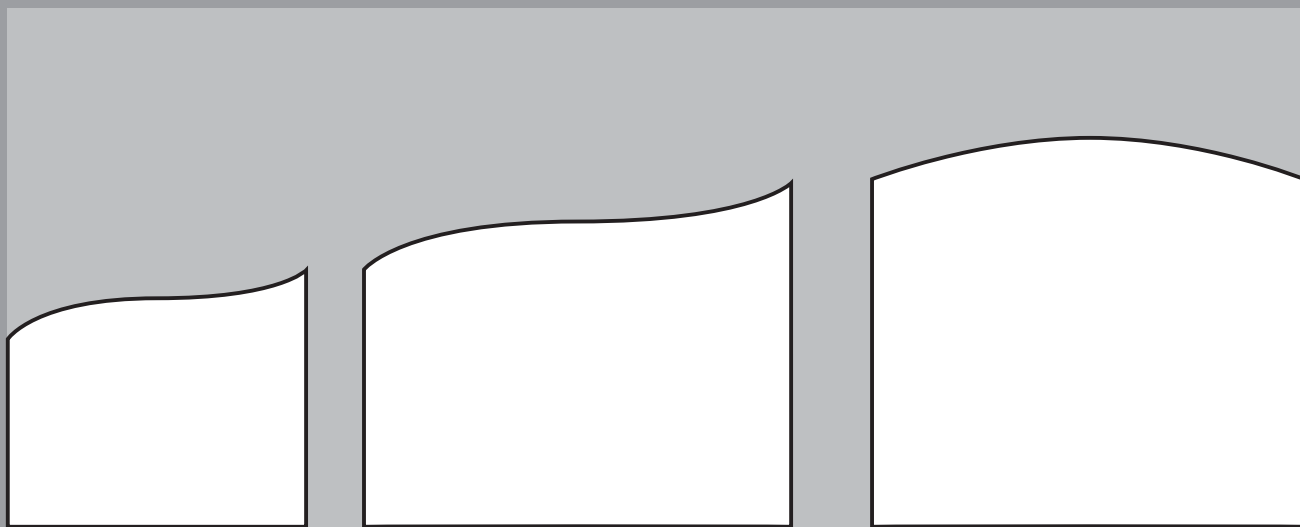

- (1) SMALL SLOPE - 7'W X 6'H X 30"D
- (1) LARGE SLOPE - 10'W X 8'H X 36"D
- (1) WAVE WALL LARGE 10'W X 9'H X 3'D

Any and all rights (including, without limitation, copyright, design patent, use patent and trademark) in and to all designs, concepts, renderings, or graphics (collectively, "Design") represented in this document were created by Pink Inc. and remain the sole and exclusive property of Pink Inc. Use of any such Design by the recipient without required purchase is strictly prohibited.

©2010

STAGE SIZE - 24'w x 12'h x 14'd

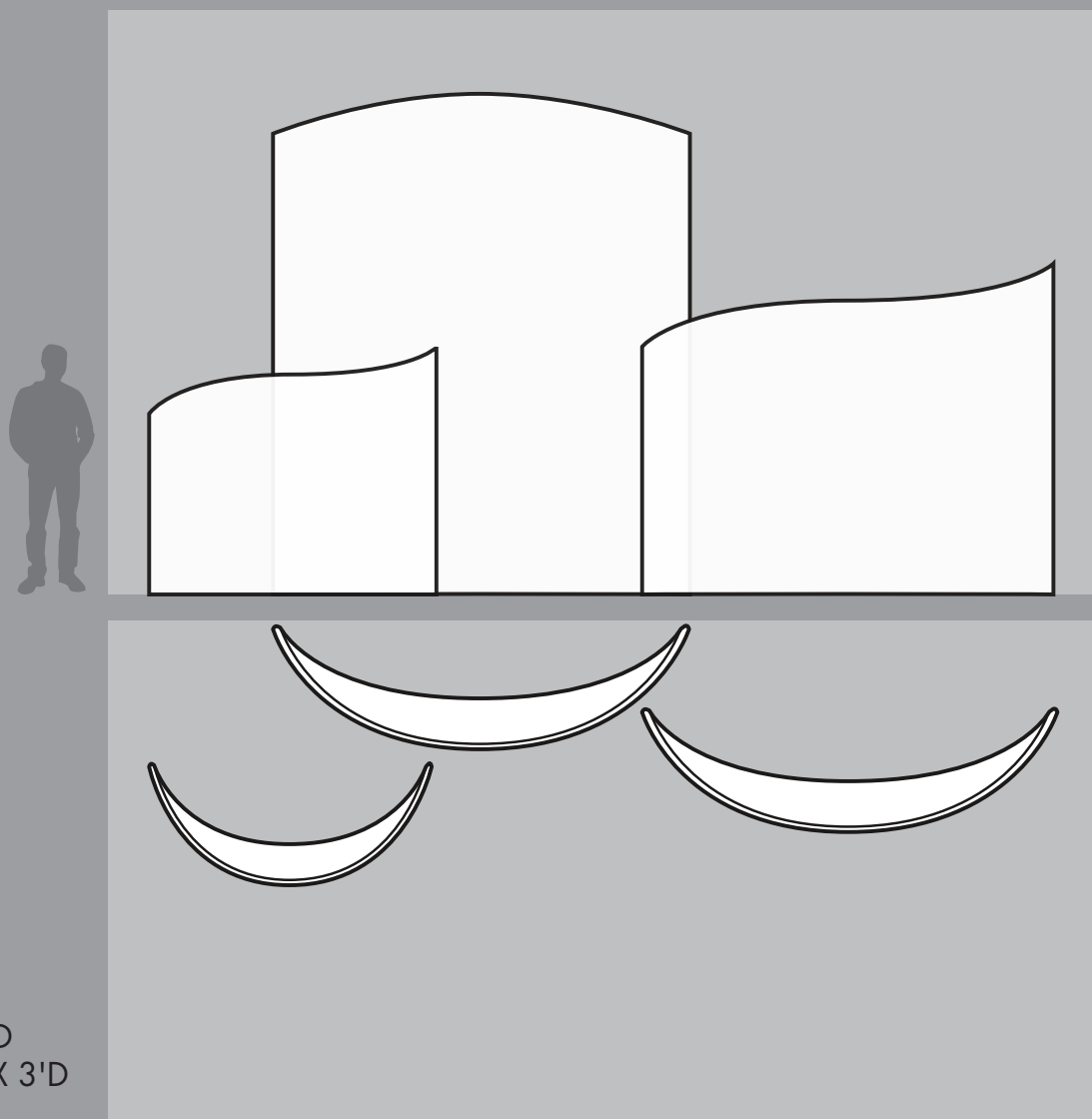

- (1) SMALL SLOPE - 7'W X 6'H X 30"D
- (1) LARGE SLOPE - 10'W X 8'H X 36"D
- (1) WAVE WALL TALL - 10'W X 12'H X 3'D

Any and all rights (including, without limitation, copyright, design patent, use patent and trademark) in and to all designs, concepts, renderings, or graphics (collectively, "Design") represented in this document were created by Pink Inc. and remain the sole and exclusive property of Pink Inc. Use of any such Design by the recipient without required purchase is strictly prohibited.

©2010

STAGE SIZE - 30'w x 15'h x 15'd

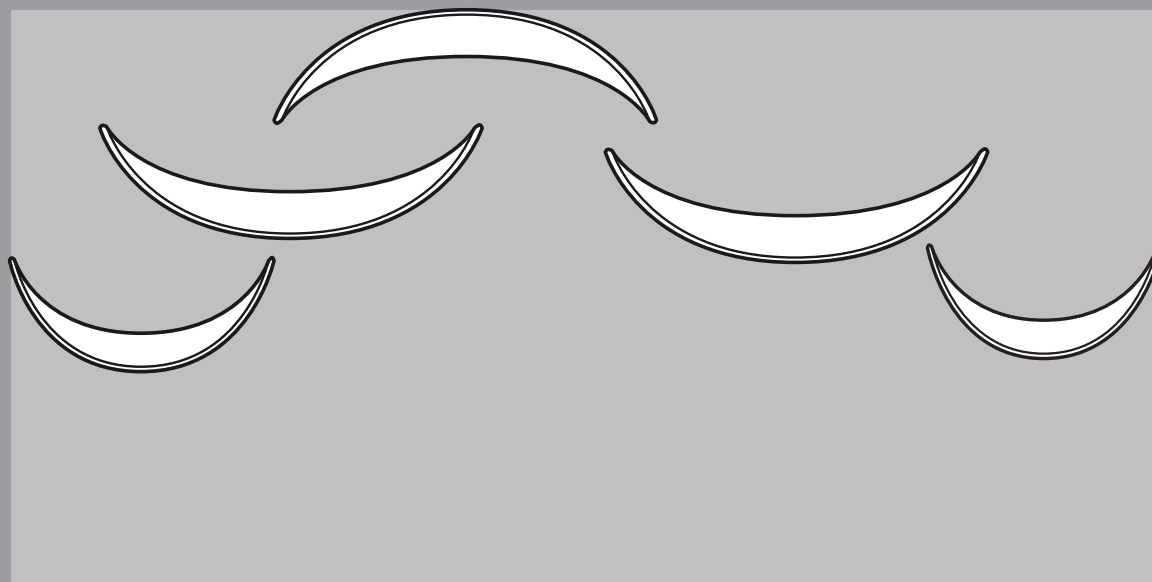
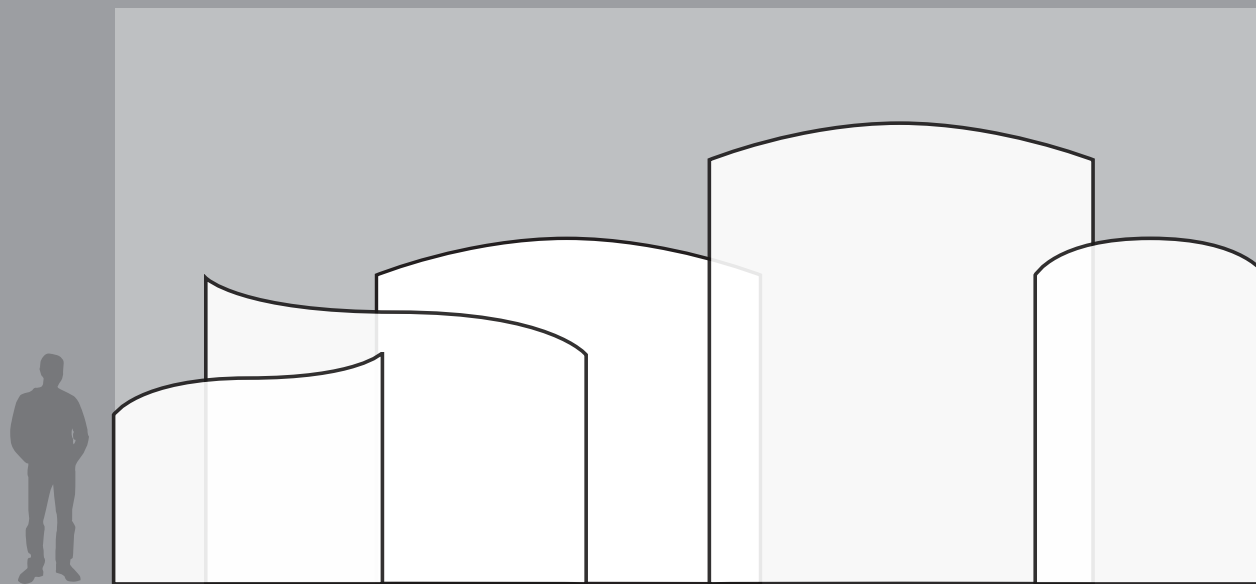

- (2) LARGE SLOPE 10'W x 8'H x 3'D
- (1) SMALL SLOPE 7'W x 6'H x 3'D
- (1) WAVE WALL LARGE 10'W x 9'H x 3'D
- (1) WAVE WALL SMALL 6'W x 9'H x 3'D
- (1) WAVE WALL TALL 10'W x 12'H x 3'D

Any and all rights (including, without limitation, copyright, design patent, use patent and trademark) in and to all designs, concepts, renderings, or graphics (collectively, "Design") represented in this document were created by Pink Inc. and remain the sole and exclusive property of Pink Inc. Use of any such Design by the recipient without required purchase is strictly prohibited.

©2010

STAGE SIZE - 30'w x 20'h x 20'd

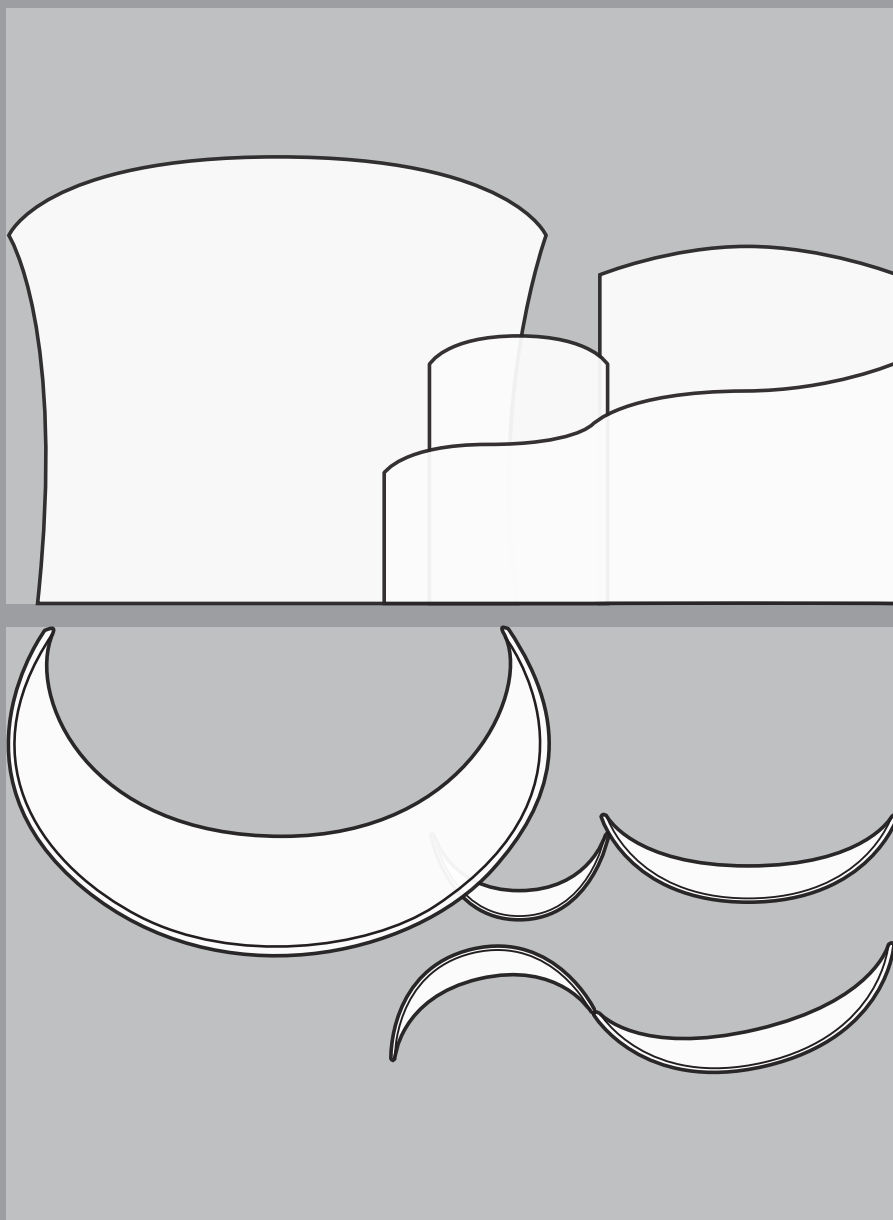

- (1) TIDAL WAVE - 18'W X 15'H X 7'D
- (1) SMALL DIVIDE - 17'W X 8'H X 5'D
- (1) WAVE WALL SMALL - 6'W X 9'H X 3'D
- (1) WAVE WALL TALL - 10'W X 12'H X 3'D

Any and all rights (including, without limitation, copyright, design patent, use patent and trademark) in and to all designs, concepts, renderings, or graphics (collectively, "Design") represented in this document were created by Pink Inc. and remain the sole and exclusive property of Pink Inc. Use of any such Design by the recipient without required purchase is strictly prohibited.

©2010

STAGE SIZE - 40'w x 16'h x 16'd

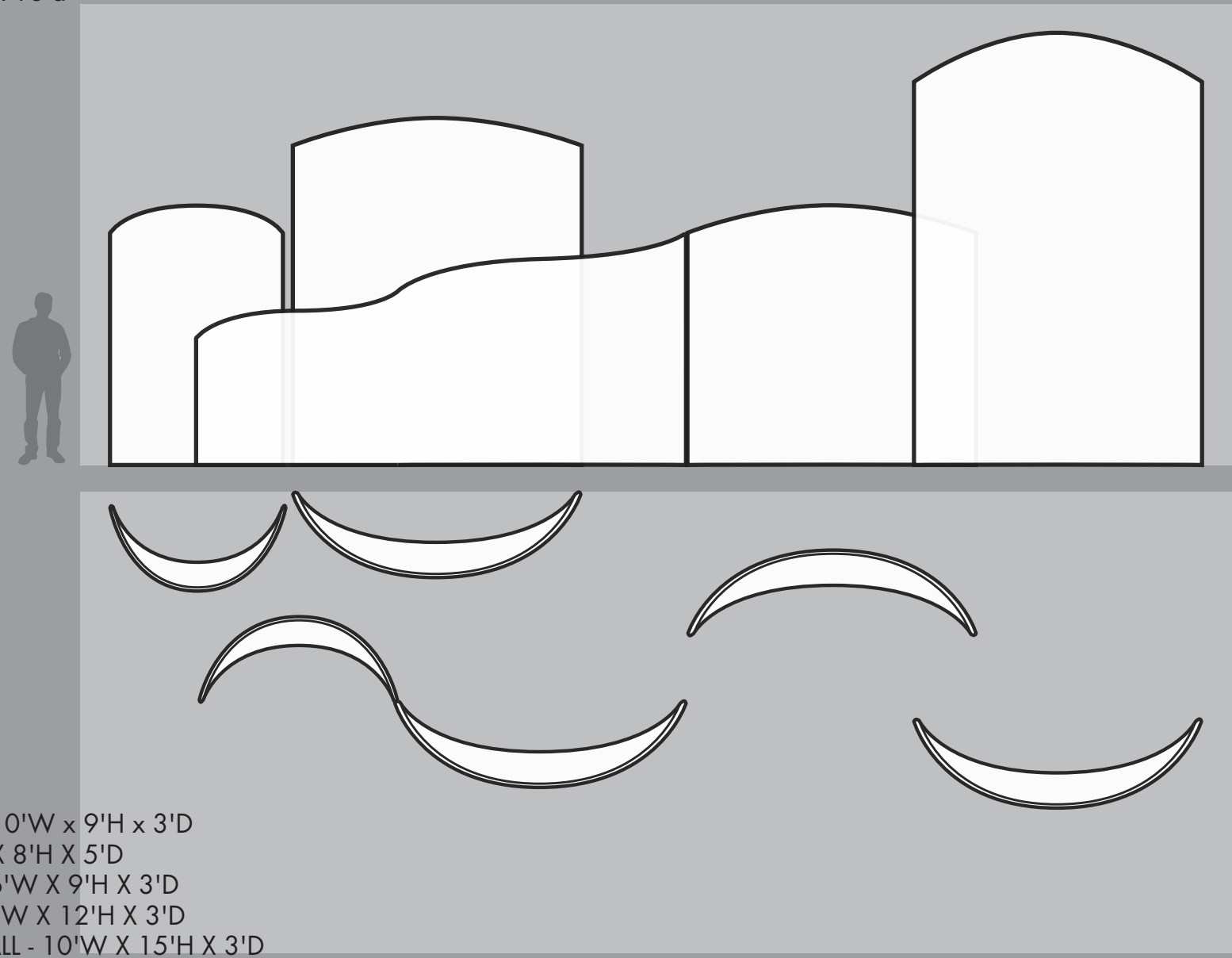

- (1) WAVE WALL LARGE - 10'W x 9'H x 3'D
- (1) SMALL DIVIDE - 17'W X 8'H X 5'D
- (1) WAVE WALL SMALL - 6'W X 9'H X 3'D
- (1) WAVE WALL TALL - 10'W X 12'H X 3'D
- (1) WAVE WALL EXTRA TALL - 10'W X 15'H X 3'D

Any and all rights (including, without limitation, copyright, design patent, use patent and trademark) in and to all designs, concepts, renderings, or graphics (collectively, "Design") represented in this document were created by Pink Inc. and remain the sole and exclusive property of Pink Inc. Use of any such Design by the recipient without required purchase is strictly prohibited.

©2010

STAGE SIZE - 48'w x 12'h x 12'd

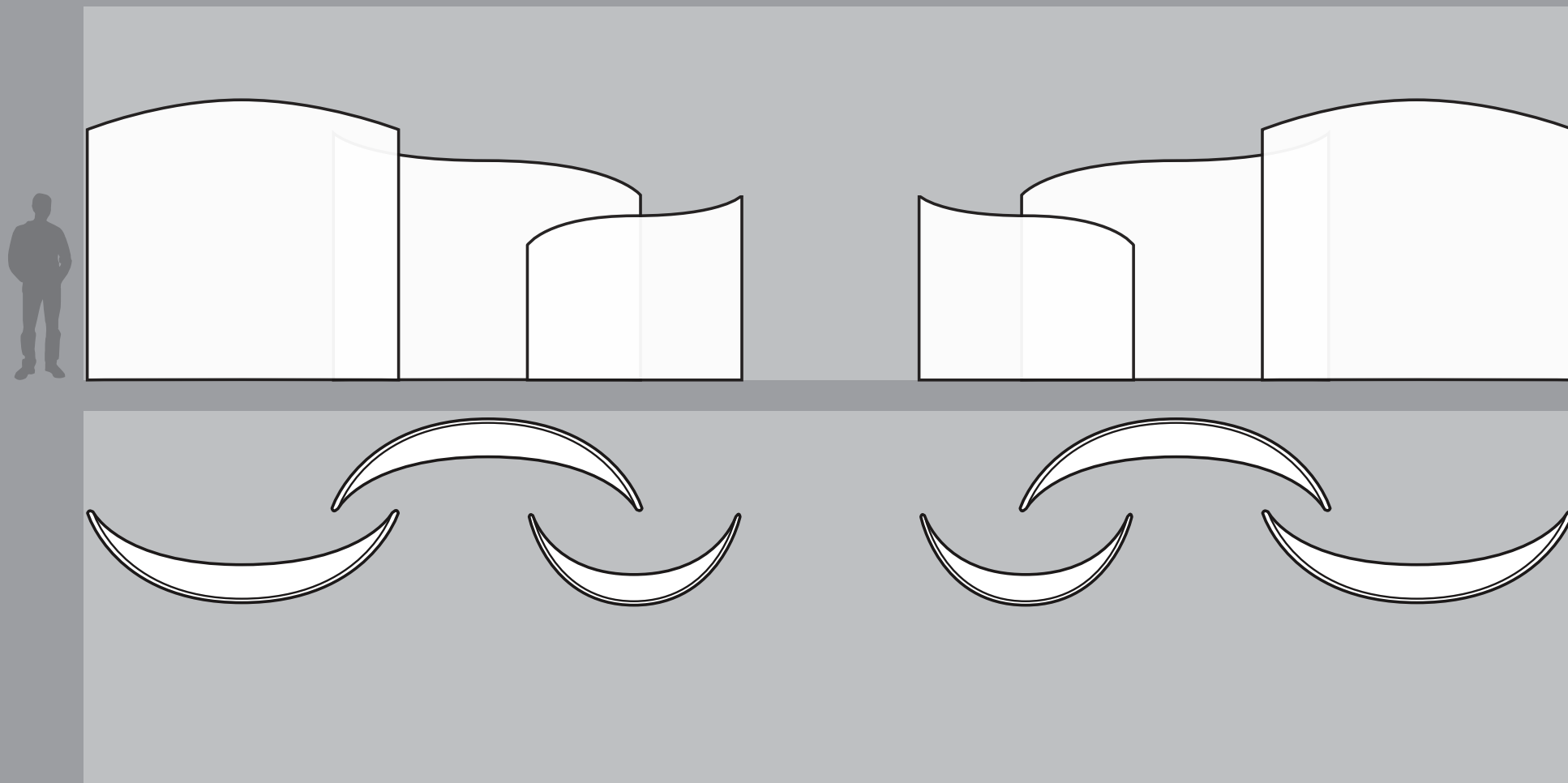

- (2) WAVE WALL LARGE - 10'W x 9'H x 3'D
- (2) LARGE SLOPE - 10'W x 8'H x 3'D
- (2) SMALL SLOPE - 7'W x 6'H x 3'D

Any and all rights (including, without limitation, copyright, design patent, use patent and trademark) in and to all designs, concepts, renderings, or graphics (collectively, "Design") represented in this document were created by Pink Inc. and remain the sole and exclusive property of Pink Inc. Use of any such Design by the recipient without required purchase is strictly prohibited.

©2010

STAGE SIZE - 40'w x 22'h x 22'd

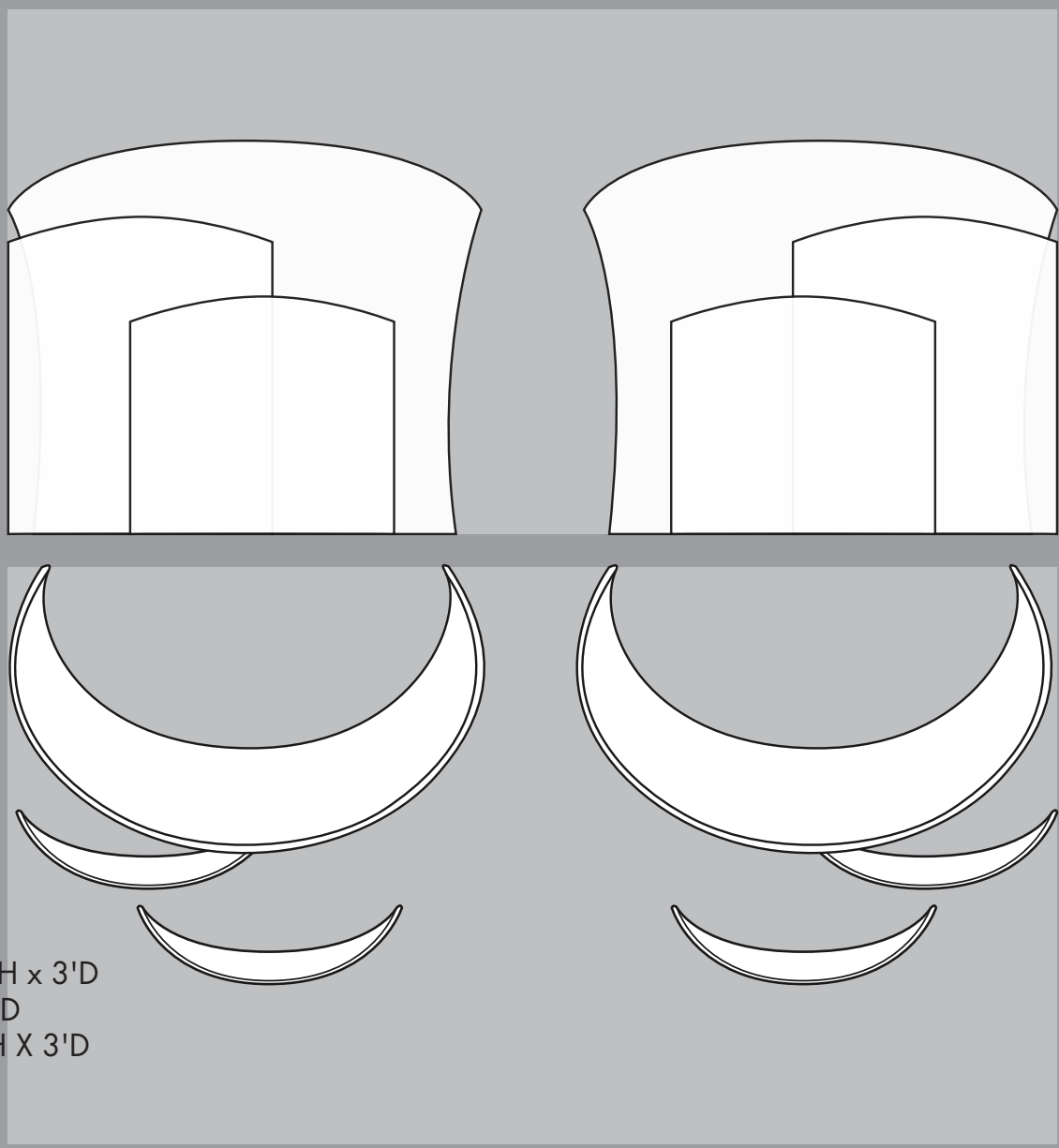

- (2) WAVE WALL LARGE - 10'W x 9'H x 3'D
- (2) TIDAL WAVE - 18'W X 15'H X 7'D
- (2) WAVE WALL TALL - 10'W X 12'H X 3'D

Any and all rights (including, without limitation, copyright, design patent, use patent and trademark) in and to all designs, concepts, renderings, or graphics (collectively, "Design") represented in this document were created by Pink Inc. and remain the sole and exclusive property of Pink Inc. Use of any such Design by the recipient without required purchase is strictly prohibited.

©2010

STAGE SIZE - 60'w x 18'h x 20'd

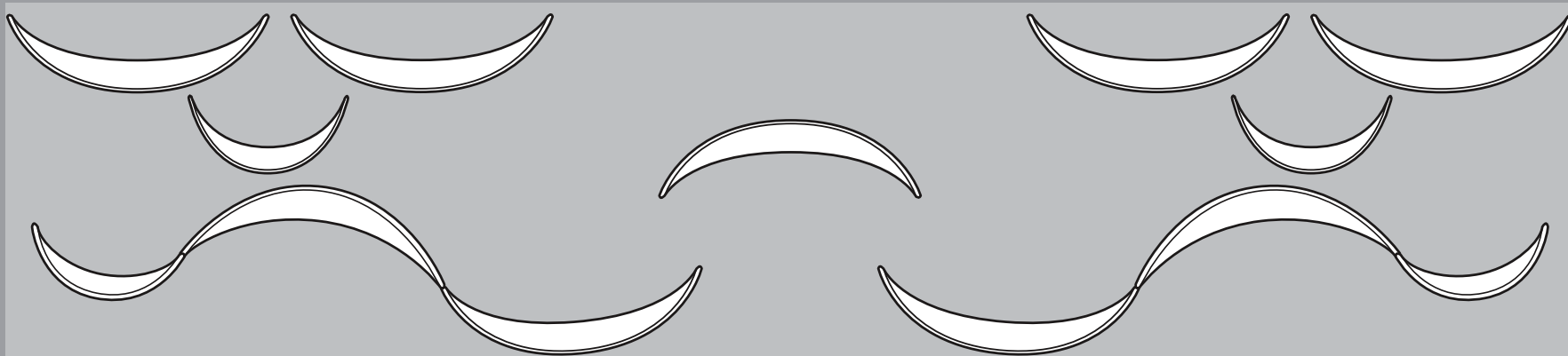
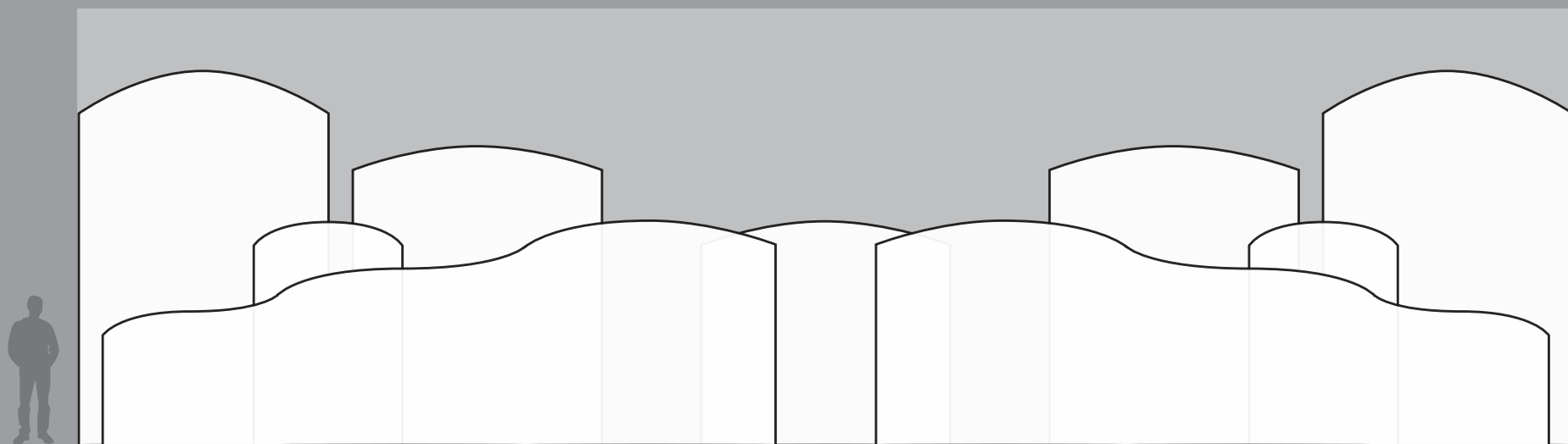

- (2) WAVE WALL SMALL - 6'W x 9'H x 3'D
- (1) WAVE WALL LARGE - 10'W x 9'H x 3'D
- (2) WAVE WALL TALL - 10'W X 12'H X 3'D
- (2) WAVE WALL EXTRA TALL - 10'W X 15'H X 3'D
- (2) CONTINENTAL DIVIDE - 27'W X 9'H X 5'D

Any and all rights (including, without limitation, copyright, design patent, use patent and trademark) in and to all designs, concepts, renderings, or graphics (collectively, "Design") represented in this document were created by Pink Inc. and remain the sole and exclusive property of Pink Inc. Use of any such Design by the recipient without required purchase is strictly prohibited.

©2010

STAGE SIZE - 60'w x 18'h x 20'd

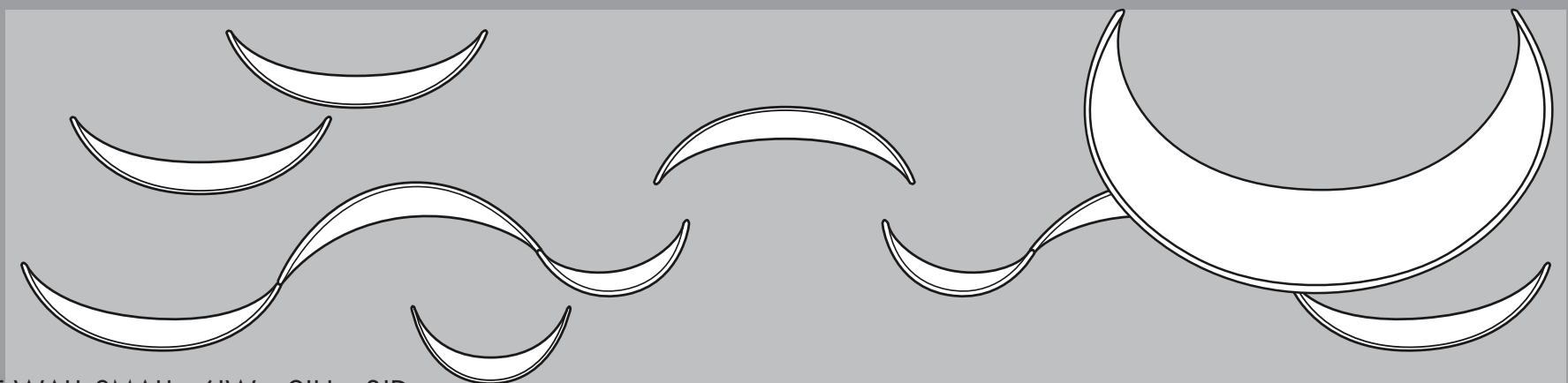
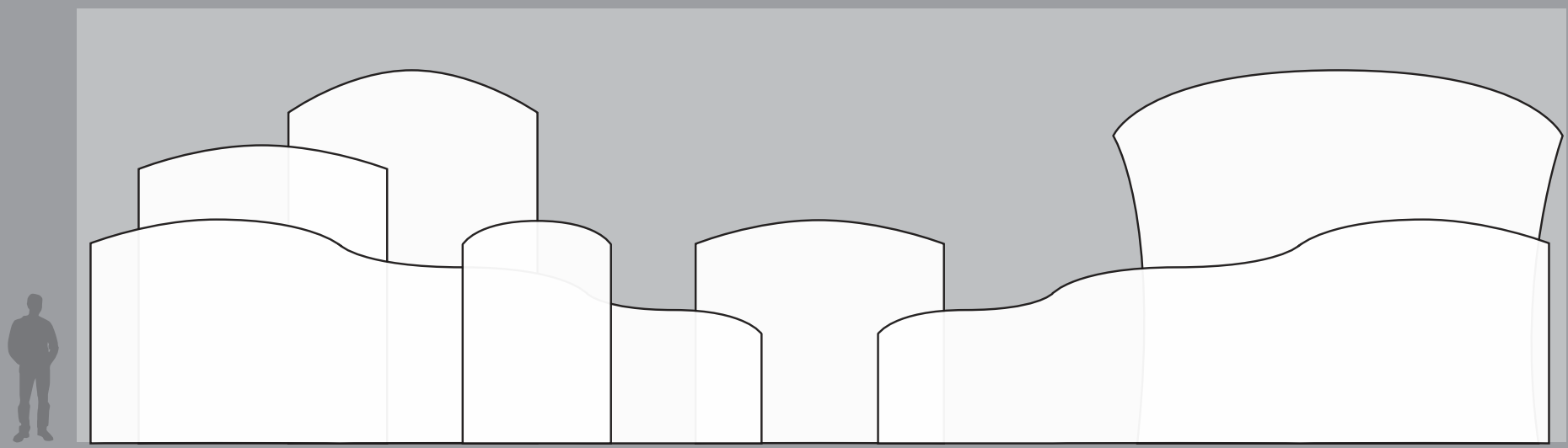

- (1) WAVE WALL SMALL - 6'W x 9'H x 3'D
- (1) WAVE WALL LARGE - 10'W x 9'H x 3'D
- (1) WAVE WALL TALL - 10'W X 12'H X 3'D
- (1) WAVE WALL EXTRA TALL - 10'W X 15'H X 3'D
- (2) CONTINENTAL DIVIDE - 27'W X 9'H X 5'D
- (1) TIDAL WAVE - 18'W X 15'H X 7'D

Any and all rights (including, without limitation, copyright, design patent, use patent and trademark) in and to all designs, concepts, renderings, or graphics (collectively, "Design") represented in this document were created by Pink Inc. and remain the sole and exclusive property of Pink Inc. Use of any such Design by the recipient without required purchase is strictly prohibited.

©2010

STAGE SIZE - 60'w x 18'h x 20'd

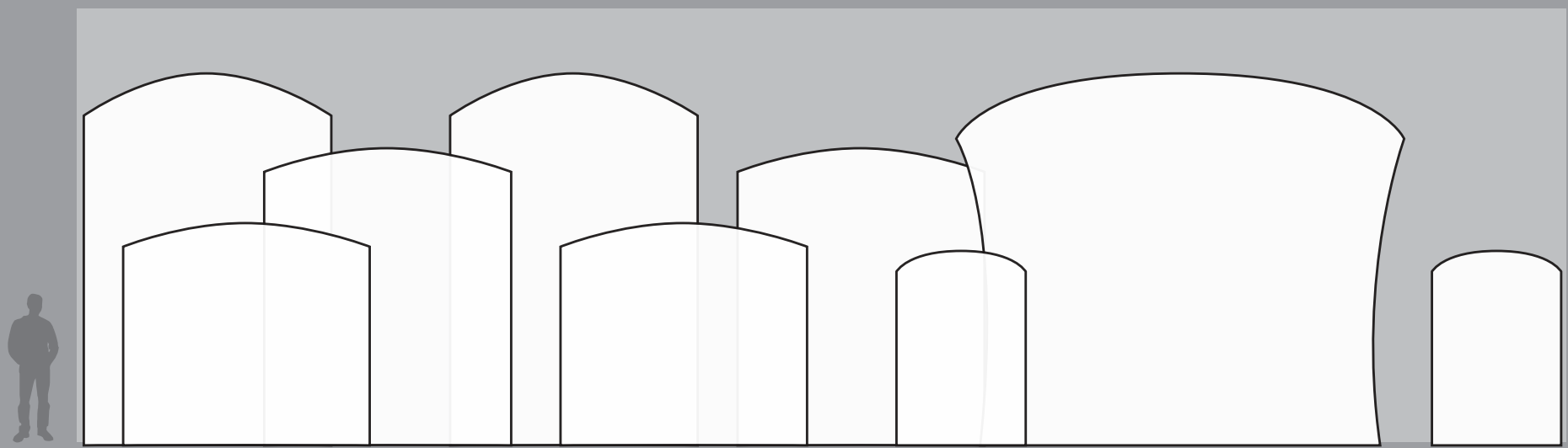

- (2) WAVE WALL SMALL - 6'W x 9'H x 3'D
- (2) WAVE WALL LARGE - 10'W x 9'H x 3'D
- (2) WAVE WALL TALL - 10'W X 12'H X 3'D
- (2) WAVE WALL EXTRA TALL - 10'W X 15'H X 3'D
- (1) TIDAL WAVE - 18'W X 15'H X 7'D

Any and all rights (including, without limitation, copyright, design patent, use patent and trademark) in and to all designs, concepts, renderings, or graphics (collectively, "Design") represented in this document were created by Pink Inc. and remain the sole and exclusive property of Pink Inc. Use of any such Design by the recipient without required purchase is strictly prohibited.

©2010

STAGE SIZE - 60'w x 18'h x 20'd

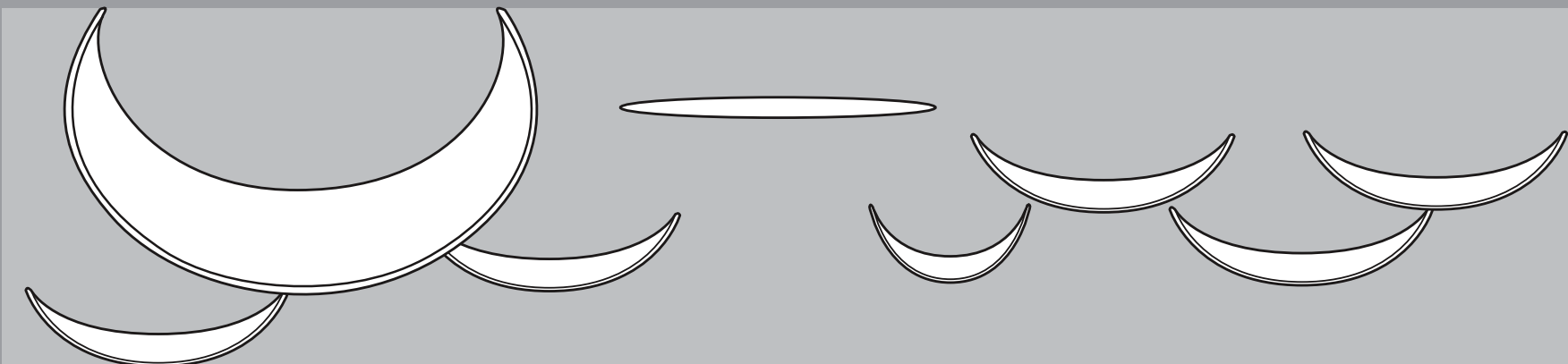
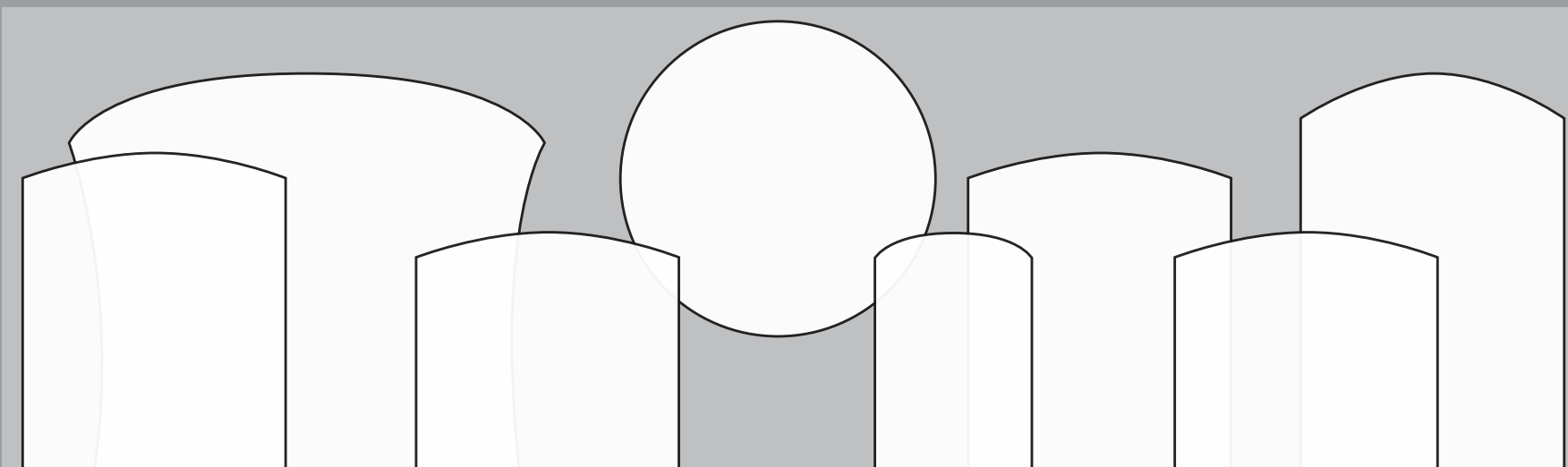

- (1) WAVE WALL SMALL - 6'W x 9'H x 3'D
- (2) WAVE WALL LARGE - 10'W x 9'H x 3'D
- (2) WAVE WALL TALL - 10'W X 12'H X 3'D
- (1) WAVE WALL EXTRA TALL - 10'W X 15'H X 3'D
- (1) TIDAL WAVE - 18'W X 15'H X 7'D
- (1) MOON - 12'

Any and all rights (including, without limitation, copyright, design patent, use patent and trademark) in and to all designs, concepts, renderings, or graphics (collectively, "Design") represented in this document were created by Pink Inc. and remain the sole and exclusive property of Pink Inc. Use of any such Design by the recipient without required purchase is strictly prohibited.

©2010

STAGE SIZE - 60'w x 18'h x 20'd

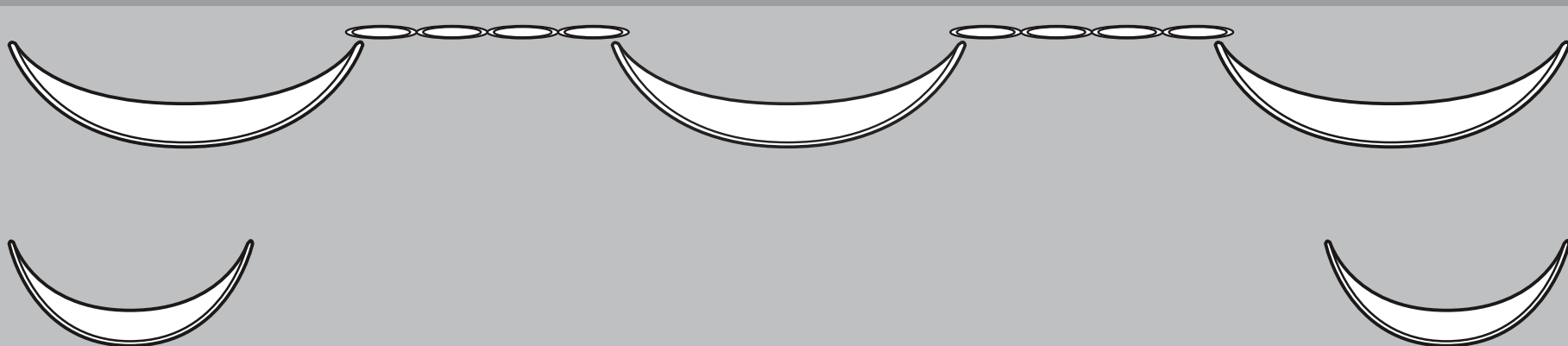
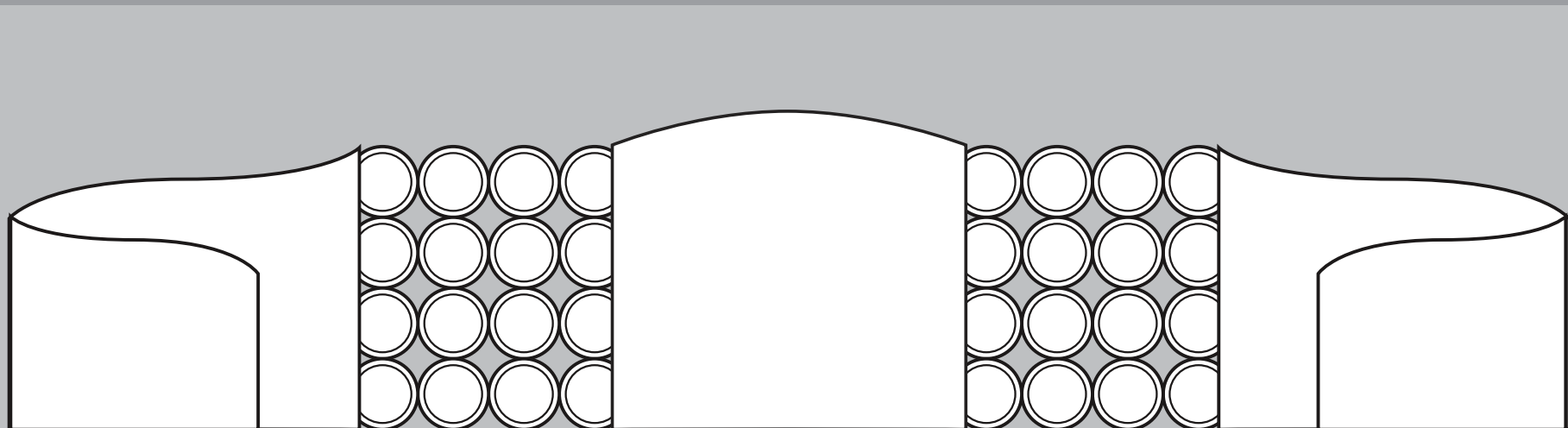

- (2) CIRCLE SURROUND - 8' x 8'
- (1) WAVE WALL LARGE - 10'W x 9'H x 3'D
- (2) SMALL SLOPE - 7'W X 6'H X 30"D
- (2) LARGE SLOPE - 10'W X 8'H X 36"D

Any and all rights (including, without limitation, copyright, design patent, use patent and trademark) in and to all designs, concepts, renderings, or graphics (collectively, "Design") represented in this document were created by Pink Inc. and remain the sole and exclusive property of Pink Inc. Use of any such Design by the recipient without required purchase is strictly prohibited.

©2010

STAGE SIZE - 30'w x 16'h x 16'd

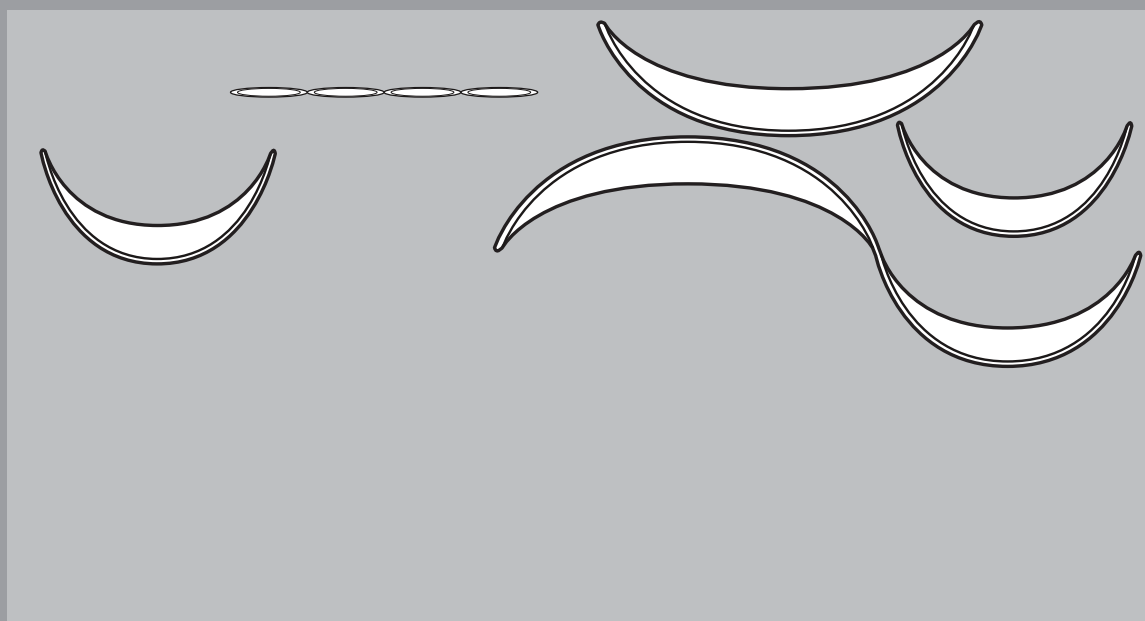
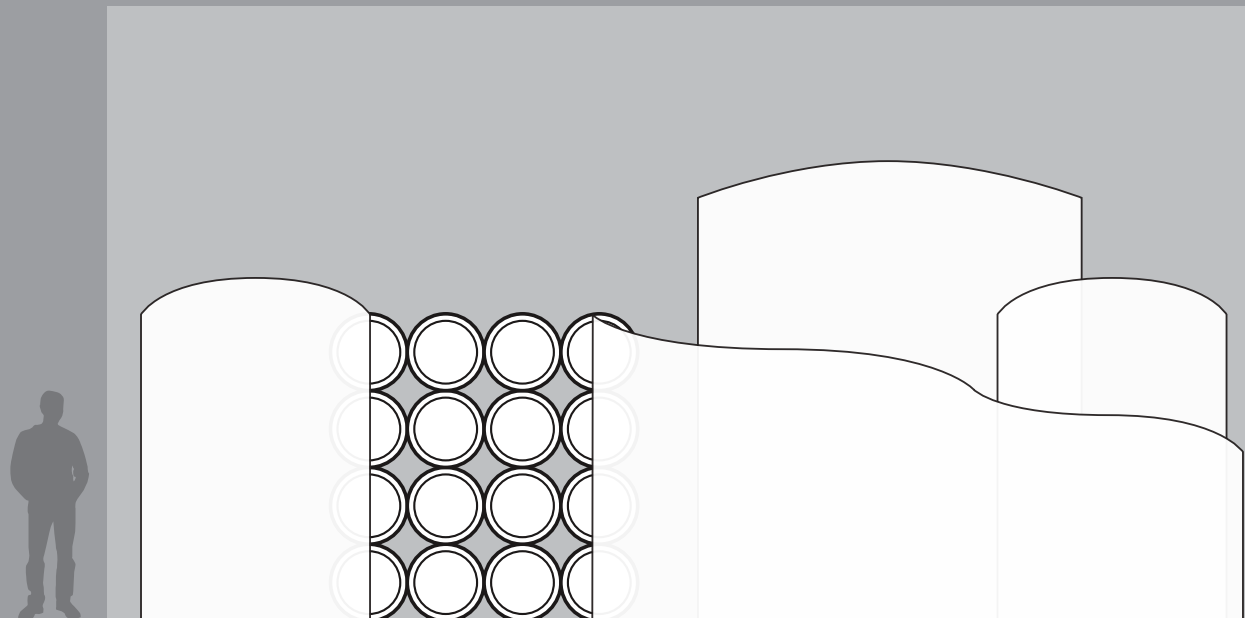

- (2) CIRCLE SURROUND - 8' x 8'
- (1) WAVE WALL SMALL - 6'W x 9'H x 3'D
- (1) WAVE WALL TALL - 10'W x 12'H x 3'D
- (2) SMALL DIVIDE - 17'W x 8'H x 5'D

Any and all rights (including, without limitation, copyright, design patent, use patent and trademark) in and to all designs, concepts, renderings, or graphics (collectively, "Design") represented in this document were created by Pink Inc. and remain the sole and exclusive property of Pink Inc. Use of any such Design by the recipient without required purchase is strictly prohibited.

©2010

STAGE SIZE - 80'w x 16'h x 16'd

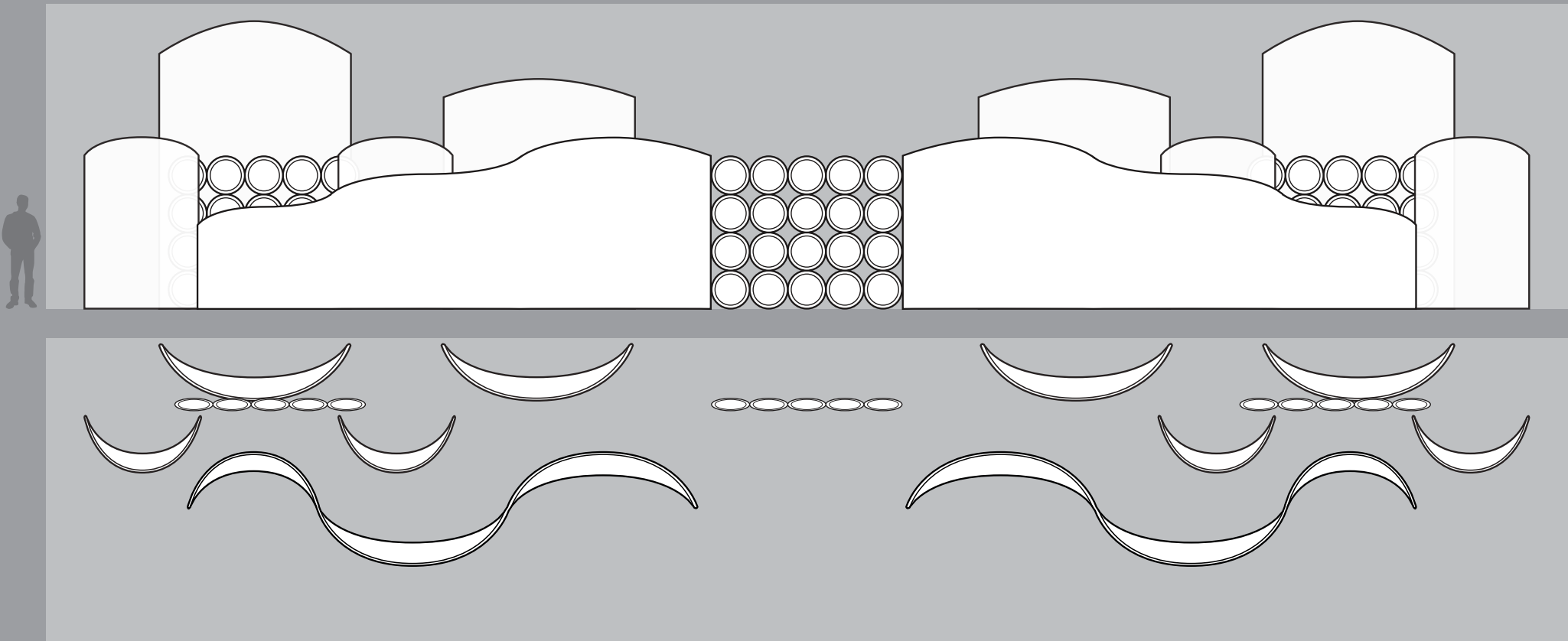

- (3) CIRCLE SURROUND - 10' x 8'
- (4) WAVE WALL SMALL - 6'W x 9'H x 3'D
- (2) WAVE WALL TALL - 10'W x 12'H x 3'D
- (2) WAVE WALL EXTRA TALL - 10'W x 12'H x 3'D
- (2) CONTINENTAL DIVIDE - 17'W x 8'H x 5'D

Any and all rights (including, without limitation, copyright, design patent, use patent and trademark) in and to all designs, concepts, renderings, or graphics (collectively, "Design") represented in this document were created by Pink Inc. and remain the sole and exclusive property of Pink Inc. Use of any such Design by the recipient without required purchase is strictly prohibited.

©2010

STAGE SIZE - 110'w x 20'h x 20'd

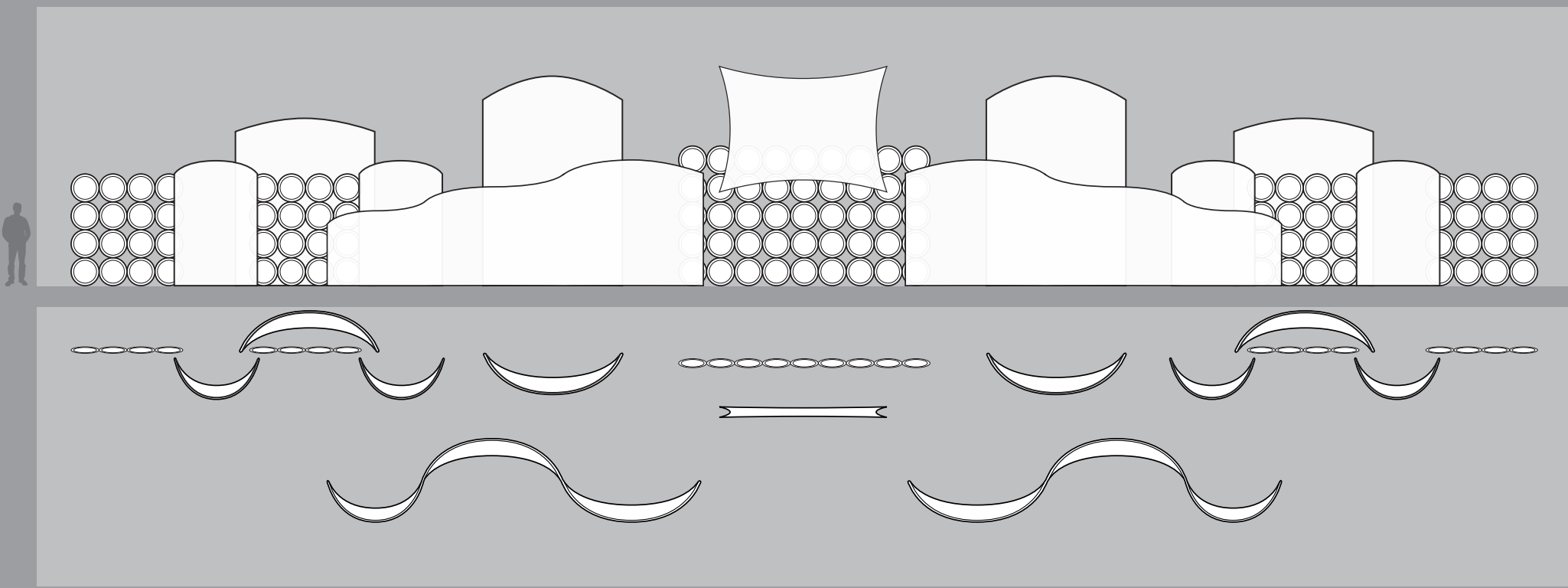

- (4) CIRCLE SURROUND - 8' x 8'
- (1) CIRCLE SURROUND - 10' x 18'
- (4) WAVE WALL SMALL - 6'W x 9'H x 3'D
- (2) WAVE WALL TALL - 10'W x 12'H x 3'D
- (2) WAVE WALL EXTRA TALL - 10'W x 12'H x 3'D
- (2) CONTINENTAL DIVIDE - 17'W x 8'H x 5'D

Any and all rights (including, without limitation, copyright, design patent, use patent and trademark) in and to all designs, concepts, renderings, or graphics (collectively, "Design") represented in this document were created by Pink Inc. and remain the sole and exclusive property of Pink Inc. Use of any such Design by the recipient without required purchase is strictly prohibited.

©2010